

Linear

LINI-R XL R007

Fixture Guide

KKDÖ

Indoor | Recessed | Output up to 265lm/m (81lm/ft)



Key applications

- ✓ Architectural detail
- ✓ Ceiling
- ✓ Direct lighting
- ✓ Downlighting
- ✓ Interior

Key features

- ✓ Custom lengths
- ✓ Constant Voltage (CV)
- ✓ Diffusion: homogenous
- ✓ Direct view
- ✓ Extensive CCT range
- ✓ IP40 dry area

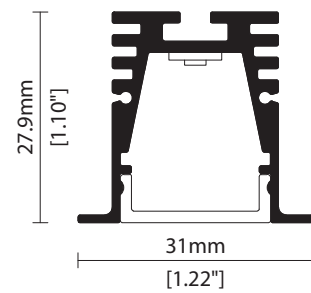

Linear

LINE-R XL R007

Specification sheet



Dimensions	H27.9/W31/L99-2016mm (H1.1/W1.22/L3.89-79.37in) (excluding spring clips)
PCB Cut-point	41.7mm increment/2000mm max (1.64in increment/78.74in max)
LED Pitch	6.95mm-144LED/m (0.27in - 44LED/ft)
Chip	s-line k-line
Cover/Optics	Diffused (110°)
CCT	s-line: 1900K/2100K/2300K/2500K/2700K/3000K/3500K/4000K/5000K Single colours: Red/Green/Blue/Orange/Amber k-line: 1900K/2100K/2300K/2500K/2700K/3000K/3500K/4000K/5000K
LED binning	s-line: 2-step MacAdam ellipse k-line: 3-step MacAdam ellipse
CRI	≥94
Lifetime	50,000 hours @ 25°C (50,000 hours @ 77°F)
Operating temp	T _a = -25 to 50°C (T _c max = 57°C) T _a = -13 to 122°F (T _c max = 135°F)
IP Rating	IP40
Finish	Silver anodised
Mounting	Recessed mounting via spring clip
Power feed	Hardwire tails or male/female connectors
Control	0-10V/1-10V/DMX/DALI



LED Grading Key

Exclusive Grade

s	s-line*	*KKDC tuned CCT range
	2-step CCT range	

Base Grade

k	k-line
	3-step commercial range Energy Star CCTs

Power consumption	Supply voltage	Supply current
7W/m (2.13W/ft)	24V DC	0.29A/m (0.09A/ft)

Performance Data (3000K)

	R1	R2	R3	R4	R5	R6	R7	R8	R9	R10	R11	R12	R13	R14
k-line	94	98	98	92	93	95	93	86	69	93	93	75	96	99

	Diffused Cover											CRI	R9	Rf	Rg
s-line	265lm/m (81lm/ft) 37.8lm/W											95	70	-	-
k-line	250lm/m (76lm/ft) 35.7lm/W											94	69	-	-

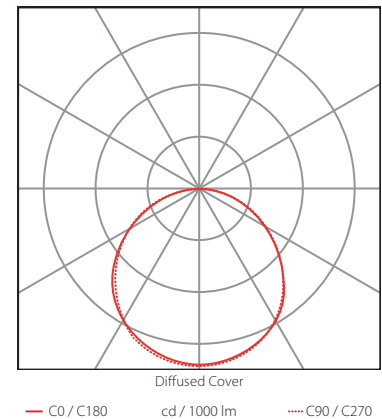
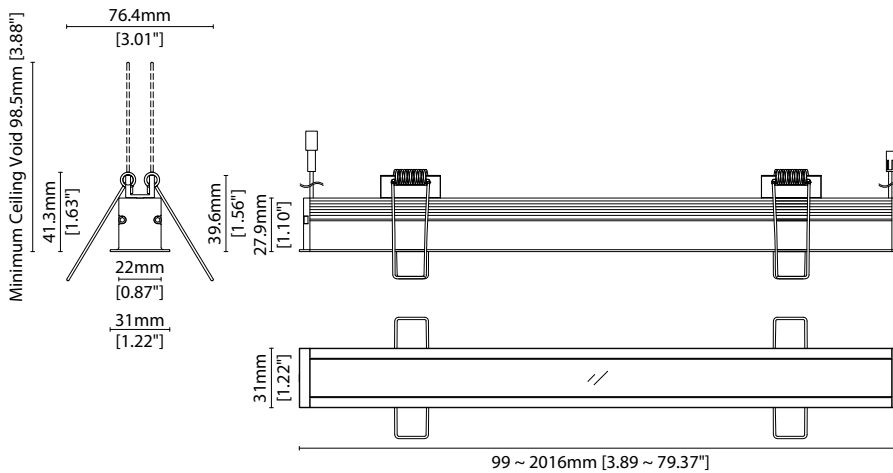

Data derived from independent UKAS/IESNA LM-79-08 accredited testing of production samples.

LINI-R XL R007

Code Table



FIXTURE

Model	Finish	Cover	Grade ¹	LED	Colour (CCT)	Length Availability ²	IP	Cable Length	Power Feed ³	Input										
LINI-R XL	RX	Silver Anodised	SA	Diffused	C	<div style="display: flex; align-items: center;"> s - s</div> <div style="display: flex; align-items: center;"> k - k </div>	R007	R007	1900K	19	m 99.3-2016mm 83.3mm increments i 3.91-79.37in 3.28in increments (Specify length code OR total run length)	IP40	40	300mm/11.81"	0300	Single no sheath tail	S00X	DC 24V	g	
									2100K	21										
									2300K	23										
									2500K	25										
									2700K	27										
									3000K	30										
									3500K	35										
									4000K	40										
									5000K	50										
									RED	RED										s-only
									GREEN	GRN										
									BLUE	BLU										
									ORANGE	ORN										
									AMBER	AMB										

¹ Refer to LED Grading Key on Specification sheet page ² Refer to Length Availability List or enter total run length instead of length code ³ Refer to Power Feed Options on Options pages

Code Example:

RX	-	SA	-	C	-	s	-	R007	-	35	-	m	516	-	40	-	0300	-	D00X	-	g
LINI-R XL		Silver Anodised		Diffused		s		R007		3500K		516mm		IP40		300mm/11.81"		Double no sheath tail		DC 24V	

ACCESSORIES

Connection Accessories

KKCN-01	2 PIN male & female 50mm/1.97" pair
KKCN-03	2 PIN male & female 300mm/11.81" pair
KKCN-06	2 PIN 300mm/11.81" extension lead

PSU/Driver

0-10V/1-10V/DALI/DMX
* Refer to Driver/PSU Options page for details or provide requirement and KKDC to offer the suitable option

* Refer to Power feed on Accessories pages

LED ENGINE VARIANTS (LED STRIP TYPE)

Colour	LED	Lumen/m	Lumen/ft	W/m	W/ft	Spec Doc	Length	Increment
Single CCT	R007	265	81	7	2.13	LINI-R XL R007	99-2016mm (3.89-79.37in)	41.7mm (3.28in)
Warm Dim/Dynamic White	R014	534	163	14	4.27	LINI-R XL R014	99-2016mm (3.89-79.37in)	41.7mm (3.28in)
	R020	731	223	20	6.10	LINI-R XL A020	99-2016mm (3.89-79.37in)	41.7mm (3.28in)
	A040	2000	610	40	12.2	LINI-R XL A040	93-1516mm (3.66-59.68in)	38.46mm (1.51in)
RGB	R207	594	181	16	4.88	LINI-R XL R207	99-2016mm (3.89-79.37in)	83.3mm (3.28in)
RGBW	501	Red 61	Red 19	15.6	4.75	LINI-R XL RGB	99-2016mm (3.89-79.37in)	83.3mm (3.28in)
		Green 132	Green 40					
		Blue 22	Blue 7					
		RGB 192	RGB 59					
RGBW	R201	441	134	20	6.10	LINI-R XL RGBW	141-2016mm (5.55-79.37in)	62.5 (2.46in)

* Performance data: A/s-line, diffused cover, 3000K

LINI-R XL R007

Length Availability List



Length Code		Fixture Length ¹		LED Strip ²		End Cap Dimension ³		Wattage (W)	Output (lm)
Metric	Imperial(US)	Metric	Imperial(US)	Metric	Imperial(US)	Metric	Imperial(US)		3000K (Test Data)
m0099	i0004	99mm	3.91in	83mm	3.28in	11mm	0.43in	0.58	21
m0141	i0006	141mm	5.55in	125mm	4.92in	11mm	0.43in	0.87	31
m0183	i0007	183mm	7.19in	167mm	6.56in	11mm	0.43in	1.17	42
m0224	i0009	224mm	8.83in	208mm	8.20in	11mm	0.43in	1.46	52
m0266	i0010	266mm	10.47in	250mm	9.84in	11mm	0.43in	1.75	62
m0308	i0012	308mm	12.11in	292mm	11.48in	11mm	0.43in	2.04	73
m0349	i0014	349mm	13.75in	333mm	13.12in	11mm	0.43in	2.33	83
m0391	i0015	391mm	15.39in	375mm	14.76in	11mm	0.43in	2.62	94
m0433	i0017	433mm	17.03in	417mm	16.40in	11mm	0.43in	2.92	104
m0474	i0019	474mm	18.67in	458mm	18.04in	11mm	0.43in	3.21	115
m0516	i0020	516mm	20.31in	500mm	19.69in	11mm	0.43in	3.50	125
m0558	i0022	558mm	21.96in	542mm	21.33in	11mm	0.43in	3.79	135
m0599	i0024	599mm	23.60in	583mm	22.97in	11mm	0.43in	4.08	146
m0641	i0025	641mm	25.24in	625mm	24.61in	11mm	0.43in	4.37	156
m0683	i0027	683mm	26.88in	667mm	26.25in	11mm	0.43in	4.67	167
m0724	i0029	724mm	28.52in	708mm	27.89in	11mm	0.43in	4.96	177
m0766	i0030	766mm	30.16in	750mm	29.53in	11mm	0.43in	5.25	187
m0808	i0032	808mm	31.80in	792mm	31.17in	11mm	0.43in	5.54	198
m0849	i0033	849mm	33.44in	833mm	32.81in	11mm	0.43in	5.83	208
m0891	i0035	891mm	35.08in	875mm	34.45in	11mm	0.43in	6.12	219
m0933	i0037	933mm	36.72in	917mm	36.09in	11mm	0.43in	6.42	229
m0974	i0038	974mm	38.36in	958mm	37.73in	11mm	0.43in	6.71	239
m1016	i0040	1016mm	40.00in	1000mm	39.37in	11mm	0.43in	7.00	250
m1058	i0042	1058mm	41.64in	1042mm	41.01in	11mm	0.43in	7.29	260
m1099	i0043	1099mm	43.28in	1083mm	42.65in	11mm	0.43in	7.58	271
m1141	i0045	1141mm	44.92in	1125mm	44.29in	11mm	0.43in	7.87	281
m1183	i0047	1183mm	46.56in	1167mm	45.93in	11mm	0.43in	8.17	292
m1224	i0048	1224mm	48.20in	1208mm	47.57in	11mm	0.43in	8.46	302
m1266	i0050	1266mm	49.84in	1250mm	49.21in	11mm	0.43in	8.75	312
m1308	i0051	1308mm	51.48in	1292mm	50.85in	11mm	0.43in	9.04	323
m1349	i0053	1349mm	53.12in	1333mm	52.49in	11mm	0.43in	9.33	333
m1391	i0055	1391mm	54.76in	1375mm	54.13in	11mm	0.43in	9.62	344
m1433	i0056	1433mm	56.40in	1417mm	55.77in	11mm	0.43in	9.92	354
m1474	i0058	1474mm	58.04in	1458mm	57.41in	11mm	0.43in	10.21	364
m1516	i0060	1516mm	59.69in	1500mm	59.06in	11mm	0.43in	10.50	375
m1558	i0061	1558mm	61.33in	1542mm	60.70in	11mm	0.43in	10.79	385
m1599	i0063	1599mm	62.97in	1583mm	62.34in	11mm	0.43in	11.08	396
m1641	i0065	1641mm	64.61in	1625mm	63.98in	11mm	0.43in	11.37	406
m1683	i0066	1683mm	66.25in	1667mm	65.62in	11mm	0.43in	11.67	416
m1724	i0068	1724mm	67.89in	1708mm	67.26in	11mm	0.43in	11.96	427
m1766	i0070	1766mm	69.53in	1750mm	68.90in	11mm	0.43in	12.25	437
m1808	i0071	1808mm	71.17in	1792mm	70.54in	11mm	0.43in	12.54	448
m1849	i0073	1849mm	72.81in	1833mm	72.18in	11mm	0.43in	12.83	458

LINI-R XL R007

Length Availability List



Length Code		Fixture Length ¹		LED Strip ²		End Cap Dimension ³		Wattage (W)	Output (lm)
Metric	Imperial(US)	Metric	Imperial(US)	Metric	Imperial(US)	Metric	Imperial(US)		3000K (Test Data)
m1891	i0074	1891mm	74.45in	1875mm	73.82in	11mm	0.43in	13.12	469
m1933	i0076	1933mm	76.09in	1917mm	75.46in	11mm	0.43in	13.42	479
m1974	i0078	1974mm	77.73in	1958mm	77.10in	11mm	0.43in	13.71	489
m2016	i0079	2016mm	79.37in	2000mm	78.74in	11mm	0.43in	14.00	500

¹ Actual total overall length of light fixture (LED strip + end caps + void/wire hole)

² Actual length of PCB strip

³ Actual length of 2x end caps

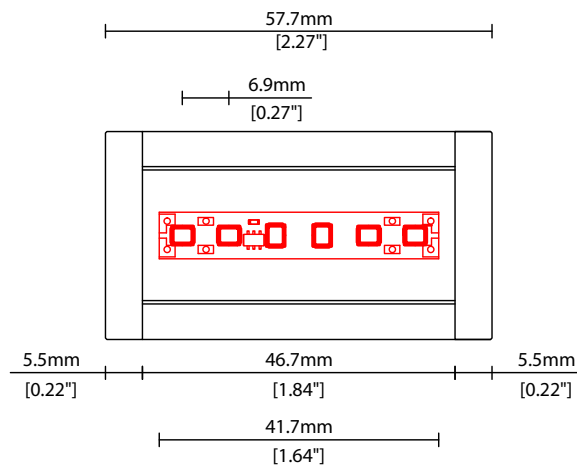



LINE-R XL R007

Options



COVER/LENS OPTIONS

* Options are an integral part of the fixture ordering codes. Please refer to **Code Table** pages.

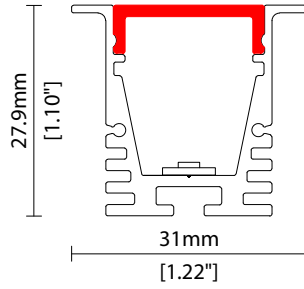

C Diffused cover
W31/H27.9mm (W1.22/H1.10")

POWER FEED OPTIONS

0300 S00X 300mm (11.81") Single no sheath tail

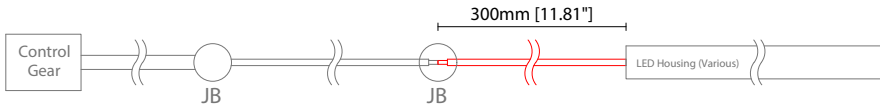

0300 D00X 300mm (11.81") Double no sheath tail

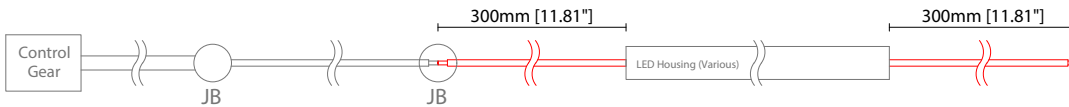

0300 S20X 300mm (11.81") Single no sheath IP20 connector

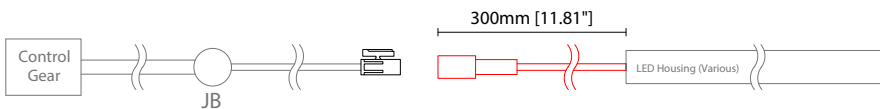

0300 D20X 300mm (11.81") Double no sheath IP20 connector

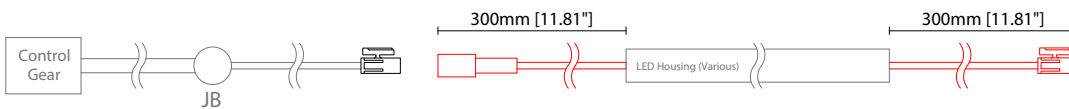

1000 S00X 1000mm (39.37") Single no sheath tail

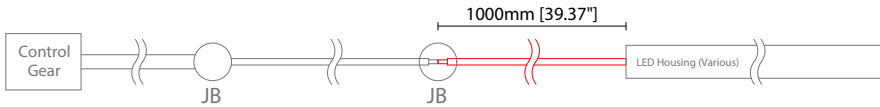

1000 D00X 1000mm (39.37") Double no sheath tail

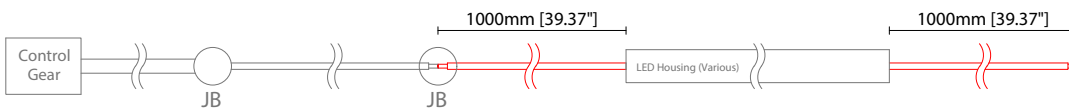

1000 S20X 1000mm (39.37") Single no sheath IP20 connector

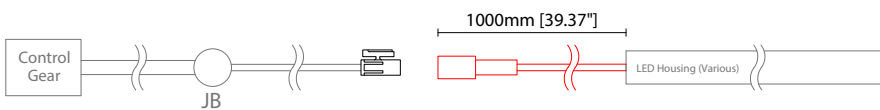

1000 D20X 1000mm (39.37") Double no sheath IP20 connector

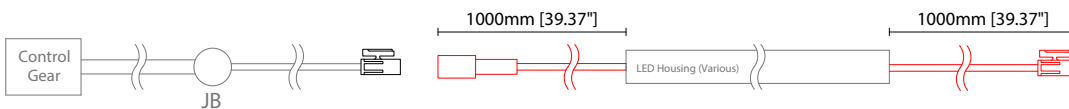

Key

Control Gear Power supply, sub-controllers & control systems
 JB Junction box / cable connection

POWER FEED OPTIONS (CONTINUED)

2 Pin Female Connector

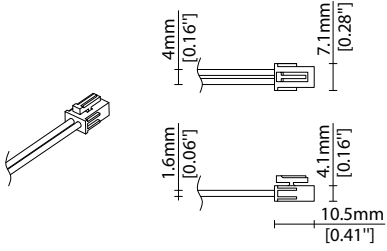

2 Pin Male Connector

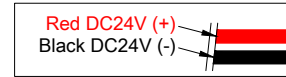
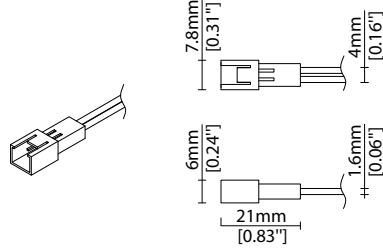

POWER FEED

Note: Accessories are to be ordered separately with corresponding code shown below.

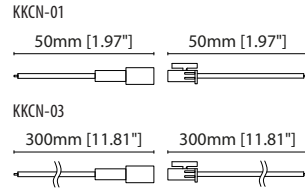
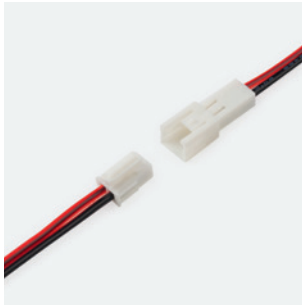

KKCN-01 50mm (1.97in) pair
KKCN-03 300mm (11.81in) pair
2 PIN male + female connector set

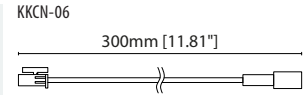

KKCN-06
2 PIN 300mm (11.81in) extension lead

KKDC CONTROL



IP20
Plastic housing
L170/W59/H29mm
(L6.69/W2.32/H1.14in)

KKDM-06 1-10V
visDIM dimmable sub-controller
(4 x 8A max @ 12-36V)



IP20
Plastic housing
L170/W53.4/H28mm
(L6.69/W2.10/H1.10in)

KKSC-05 DMX
visDIM dimmable sub-controller
(4 x 5A max @ 12-36V)



IP20
Plastic housing
L170/W59/H29mm
(L6.69/W2.32/H1.14in)

KKDL-02 DALI
visDIM dimmable sub-controller
(4 x 8A max @ 12-36V)



IP20
Plastic housing
L166/W53.4/H23mm
(L6.54/W2.10/H0.91in)

KKDL-03 DALI
visDIM dimmable sub-controller
(4 x 5A max @ 12-36V)

AVAILABLE PSU OPTIONS

Control Mode	PSU (Order Code)	Input Voltage AC	Output Voltage DC	Rated Output Current	Rated Power	Dim %	IP Rating
Switched	CEN-60-24	90-295V	24V	2.5A	60W	-	IP67
	HLG-60H-24	90-305V	24V	2.5A	60W	-	IP67
	HLG-100H-24	90-305V	24V	4.0A	100W	-	IP67
	HLG-150H-24	90-305V	24V	6.3A	150W	-	IP67
	HLG-240H-24	90-305V	24V	10A	240W	-	IP67
0-10V (1-10V)	PWM-40-24	90-305V	24V	1.67A	40W	100-0.15 (100-10)	IP67
	PWM-60-24	90-305V	24V	2.5A	60W	100-0.15 (100-10)	IP67
	PWM-90-24	90-305V	24V	3.67A	90W	100-0.15 (100-10)	IP67
	PWM-120-24	90-305V	24V	5.0A	120W	100-0.15 (100-10)	IP67
DALI	LIN100A1	120-277V	24V	1A per channel	100W	100-0.1	IP66/IP40
DMX RGB	LIN100A1	120-277V	24V	1.33A per channel	100W	100-0.1	IP66/IP40
DMX RGBW	LIN100A1	120-277A	24V	1A per channel	100W	100-0.1	IP66/IP40

Flicker Free Options - Combination of PSU+ sub-controller

Control Mode	PSU (Order Code)	Sub-controller (Order Code)	Input Voltage AC	Output Voltage DC	Rated Output Current	Rated Power	Dim %	IP Rating PSU/ Sub-controller
0-10V or 1-10V	CEN-60-24	KKDM-06	90-295V	24V	2.5A	60W	100-0.9	IP67/IP20
	HLG-60H-24	KKDM-06	90-295V	24V	2.5A	60W	100-0.9	IP67/IP20
	HLG-100H-24	KKDM-06	90-295V	24V	4.0A	100W	100-0.9	IP67/IP20
	HLG-150H-24	KKDM-06	90-295V	24V	6.3A	150W	100-0.9	IP67/IP20
	HLG-240H-24	KKDM-06	90-295V	24V	10.0A	240W	100-0.9	IP67/IP20
DALI	CEN-60-24	KKDL-02/03	90-295V	24V	2.5A	60W	100-0.1	IP67/IP20
	HLG-60H-24	KKDL-02/03	90-305V	24V	2.5A	60W	100-0.1	IP67/IP20
	HLG-100H-24	KKDL-02/03	90-305V	24V	4.0A	100W	100-0.1	IP67/IP20
	HLG-150H-24	KKDL-02/03	90-305V	24V	6.3A	150W	100-0.1	IP67/IP20
	HLG-240H-24	KKDL-02/03	90-305V	24V	10.0A	240W	100-0.1	IP67/IP20
DMX RGB	CEN-60-24	KKSC-05	90-295V	24V	2.5A	60W	100-0.9	IP67/IP20
	HLG-60H-24	KKSC-05	90-305V	24V	2.5A	60W	100-0.9	IP67/IP20
	HLG-100H-24	KKSC-05	90-305V	24V	4A	100W	100-0.9	IP67/IP20
	HLG-150H-24	KKSC-05	90-305V	24V	6.3A	150W	100-0.9	IP67/IP20
	HLG-240H-24	KKSC-05	90-305V	24V	10.0A	240W	100-0.9	IP67/IP20

¹ The items shown above cover the most frequently used specification but does not exhaust the possible options

² PSU and/or driver can be chosen from the table, or KKDC may recommend the best option upon receipt of the controls requirement and installation environment

³ Electrical shop drawing will include detailed information of PSU and relevant control drivers

⁴ Cut sheets are available on the controls section of www.kkdc.lighting or upon request